

5mm Round Standard T-1 3/4 Type
Infrared LED
Technical Data Sheet

Part No.: DL-503IRTA-2IR45

Double Light

◆ Features:

1. Standard T-1 3/4 diameter package.
2. Low forward voltage.
3. Viewing angle=45°.
4. Reliable and rugged.
5. The product itself will remain within RoHS complaint Version.

◆ Descriptions:

1. The device is spectrally matched with silicon photodiode and phototransistor.

◆ Applications:

1. Floppy disk drive.
2. Optoelectronic switch.
3. Camera.
4. Free air transmission system.
5. Video.

◆ BIN Rankings

Bin Code	Test Condition	Radiant Intensity (mW/sr)		VF(V)
		Min	Max	
A	IF=20mA	10	20	1.0-1.1
B		20	30	1.1-1.2
C		30	40	1.2-1.3
D		40	50	1.3-1.4
E		50	60	1.4-1.5

◆ Package Dimension:

Double Light

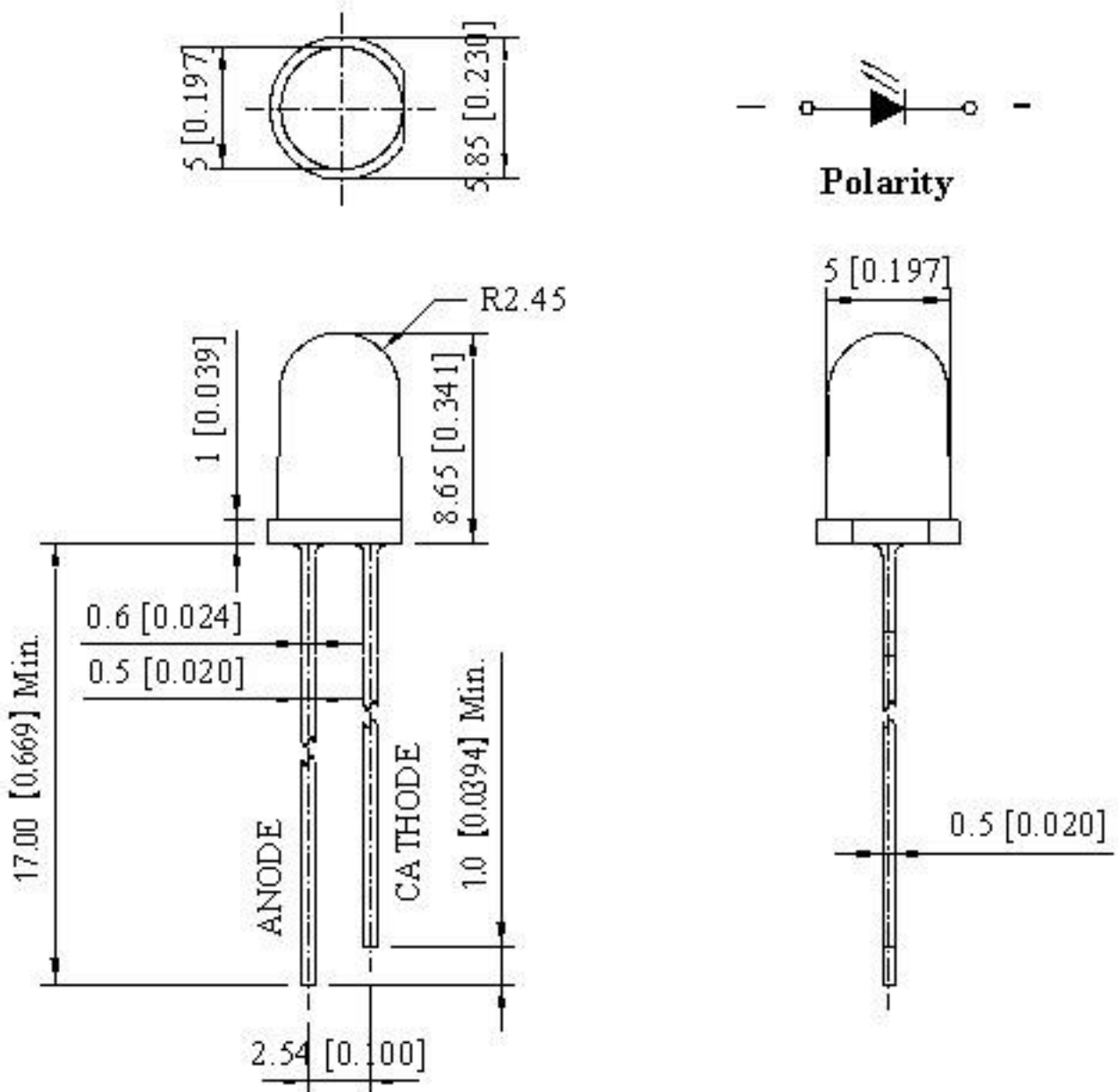

Part No.	Chip Material	Lens Color	Source Color
DL-503IRTA-2IR45	GaAlAs	Blue Clear	Infrared

Notes:

1. All dimensions are in millimeters (inches).
2. Tolerance is ± 0.25 mm (.010") unless otherwise specified.
3. Protruded resin under flange is 1.00 mm (.039") max.
4. Specifications are subject to change without notice.

◆ Absolute Maximum Ratings at Ta=25°C

Double Light

Parameters	Symbol	Max.	Unit
Power Dissipation	PD	100	mW
Peak Forward Current (1/10 Duty Cycle, 0.1ms Pulse Width)	IFP	1.00	A
Forward Current	IF	100	mA
Reverse Voltage	VR	5	V
Operating Temperature Range	Topr	-40°C to +80°C	
Storage Temperature Range	Tstg	-40°C to +85°C	
Soldering Temperature	Tsld	260°C for 5 Seconds	

Electrical Optical Characteristics at Ta=25°C

Parameters	Symbol	Min.	Typ.	Max.	Unit	Test Condition
Radiant Intensity (Note 1) *	Ee	20.5	35.0	50.0	mW/sr	IF=20mA
		---	95.0	---		IF=100mA, tp=100μs, tp/T=0.01
Viewing Angle (Note 2) *	2θ _{1/2}	---	45	---	Deg	IF=20mA
Peak Emission Wavelength	λ _p	---	940	---	nm	IF=20mA (Note 3)
Spectral Bandwidth	Δλ	---	50	---	nm	IF=20mA
Forward Voltage	VF	1.00	1.20	1.50	V	IF=20mA
		1.30	1.50	1.70		IF=100mA, tp=100μs, tp/T=0.01
Reverse Current	IR	---	---	10	μA	V _R =5V

Notes:

- Luminous (Radiant) Intensity Measurement allowance is ± 10%.
- θ_{1/2} is the off-axis angle at which the luminous intensity is half the axial luminous intensity.
- The dominant wavelength (λ_p) is derived from the CIE chromaticity diagram and represents the single wavelength which defines the color of the device.

◆ Typical Electrical / Optical Characteristics Curves

(25°C Ambient Temperature Unless Otherwise Noted)

Double Light

Spectral Distribution

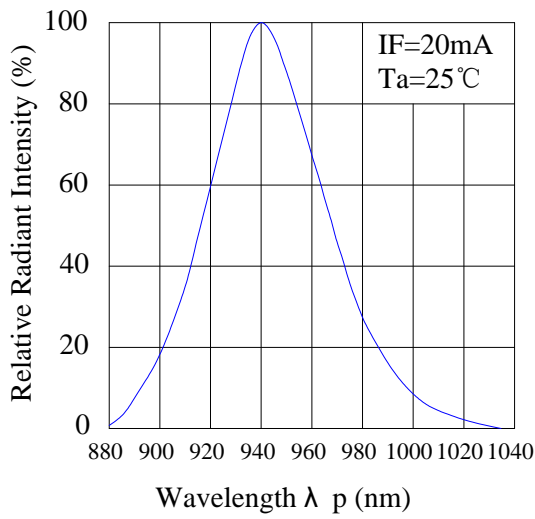

Forward Current & Forward Voltage

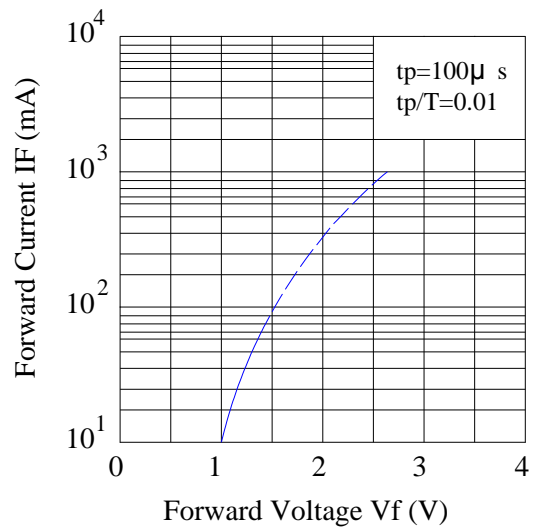

Peak Emission Wavelength & Ambient Temperature

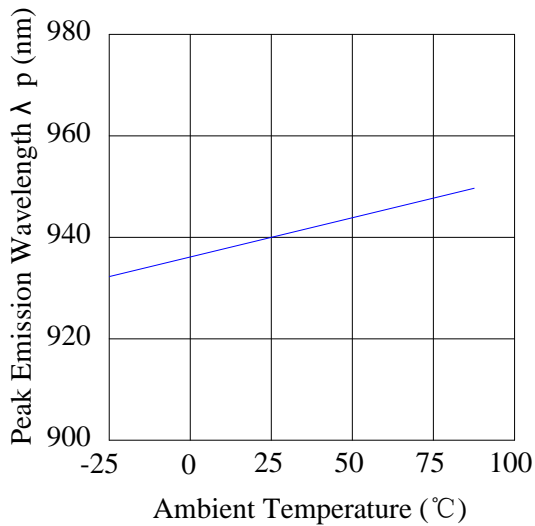

Forward Current & Ambient Temperature

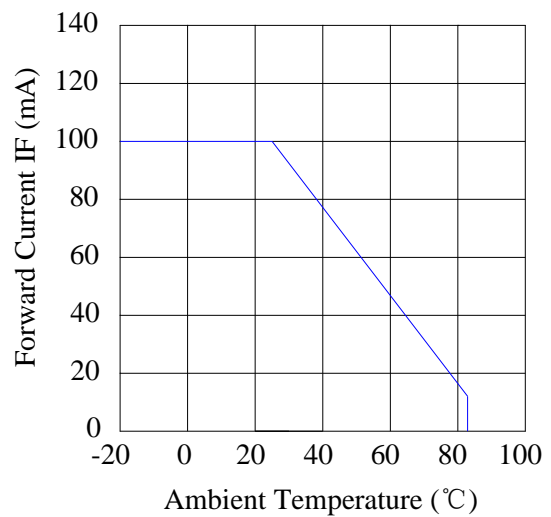

Double Light

Relative Intensity & Ambient Temperature

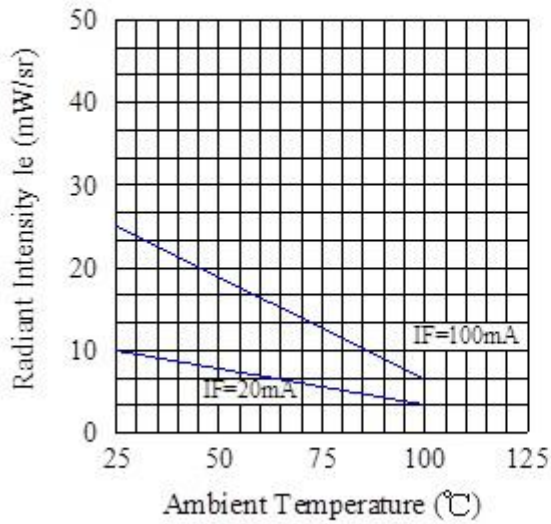

Forward Voltage & Ambient Temperature

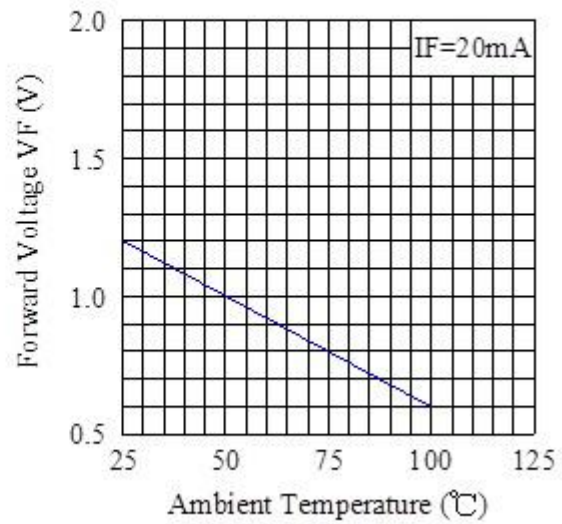

Relative Intensity & Forward Current

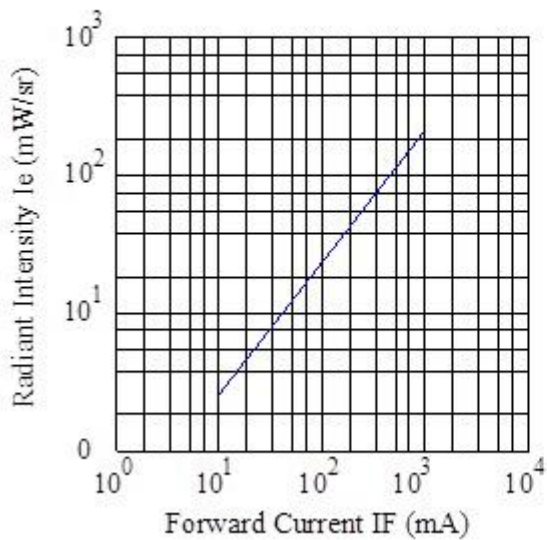

Relative Radiant Intensity & Angular Displacement

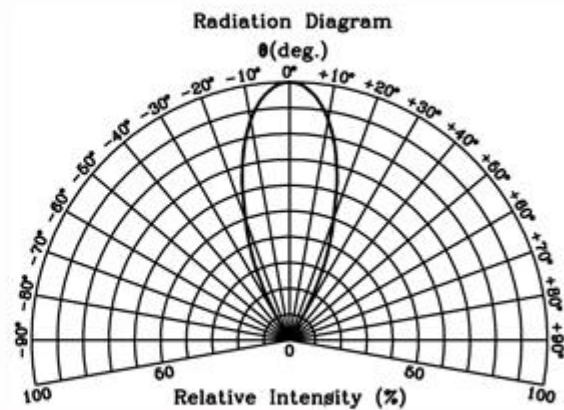

Double Light

◆ Reliability Test Items And Conditions:

The reliability of products shall be satisfied with items listed below:

Confidence level: 90%.

LTPD: 10%.

No.	Item	Test Conditions	Test Hours/ Cycles	Sample Sizes	Failure Judgment Criteria	Ac/ Re
1	Reflow Soldering	TEMP.: 260°C±5°C 5secs	6mins	22pcs	$IR \geq U*2$ $Ee \leq L*0.8$ $VF \geq U*1.2$ U: Upper Specification Limit L: Lower Specification Limit	0/1
2	Temperature Cycle	H: +100°C 15mins ┆ 5 mins ┆ L: -40°C 15mins	50Cycles	22pcs		0/1
3	Thermal Shock	H: +100°C 15mins ┆ 10mins ┆ L: -10°C 5mins	50Cycles	22pcs		0/1
4	High Temperature Storage	TEMP.: +100°C	1000hrs	22pcs		0/1
5	Lower Temperature Storage	TEMP.: -40°C	1000hrs	22pcs		0/1
6	DC Operating Life	V _{CE} =5V	1000hrs	22pcs		0/1
7	High Temperature/ High Humidity	85°C / 85% R.H	1000hrs	22pcs		0/1

Double Light

◆ Please read the following notes before using the product:

1. Over-current-proof

Customer must apply resistors for protection, otherwise slight voltage shift will cause big current change (Burn out will happen).

2. Storage

2.1 Do not open moisture proof bag before the products are ready to use.

2.2 Before opening the package, the LEDs should be kept at 30°C or less and 90% RH or less.

2.3 The LEDs should be used within a year.

2.4 After opening the package, the LEDs should be kept at 30°C or less and 70% RH or less.

2.5 The LEDs should be used within 168 hours (7 days) after opening the package.

3. Soldering Iron

Each terminal is to go to the tip of soldering iron temperature less than 260°C for 5 seconds within once in less than the soldering iron capacity 25W. Leave two seconds and more intervals, and do soldering of each terminal. Be careful because the damage of the product is often started at the time of the hand solder.

4. Repairing

Repair should not be done after the LEDs have been soldered. When repairing is unavoidable, a double-head soldering iron should be used (as below figure). It should be confirmed beforehand whether the characteristics of the LEDs will or will not be damaged by repairing.